

HDPE Pipe Fittings

PIPE & FITTING SYSTEMS





The Plastics Experts.

AGRU Pipe & Fitting Systems offer a complete range of high-quality pipes, fittings, valves and customized components made from polyethylene. Built for the safe and environmentally sensitive supply of gas, potable water and wastewater transport, AGRU solutions are built with years of experience, a highly knowledgeable staff and state-of-the-art manufacturing equipment.

The AGRU success story has been unfolding now for about seven decades. Founded in 1948 by Alois Gruber Sr., the company has grown to become one of the world's most important single-source suppliers for piping systems, semi-finished products, concrete protection liners and lining systems made from engineered plastics. Our ability to supply everything from a single source sets us apart. We use only the highest-grade thermoplastic polymers as our raw materials and, when it comes to application-technical consulting, AGRU is your best partner in the field.



Quality

At AGRU, customer satisfaction comes first. Technical consultations, training courses, welding instruction and expert supervision on site are essential to the installation of our products. Our start-to-finish attention to quality ensures that our products meet and beat the strictest technical specifications, providing safe operation within gas, water and wastewater infrastructures.

HDPE Pipe Fittings

AGRU America manufactures high-density polyethylene (HDPE) pipe fittings from the newest generation of PPI and NSF materials. These fittings meet a range of project requirements including ASTM D3261, ASTM D2513, NSF 61, and AWWA C901 and C906. HDPE offers superior flow characteristics while retaining its lightweight and flexible properties.

Principal applications include wastewater, potable water, oil and gas gathering, gas distribution, mining, landfill, industrial, and irrigation.



Electrofusion Fittings



Molded Fittings



Backing Rings

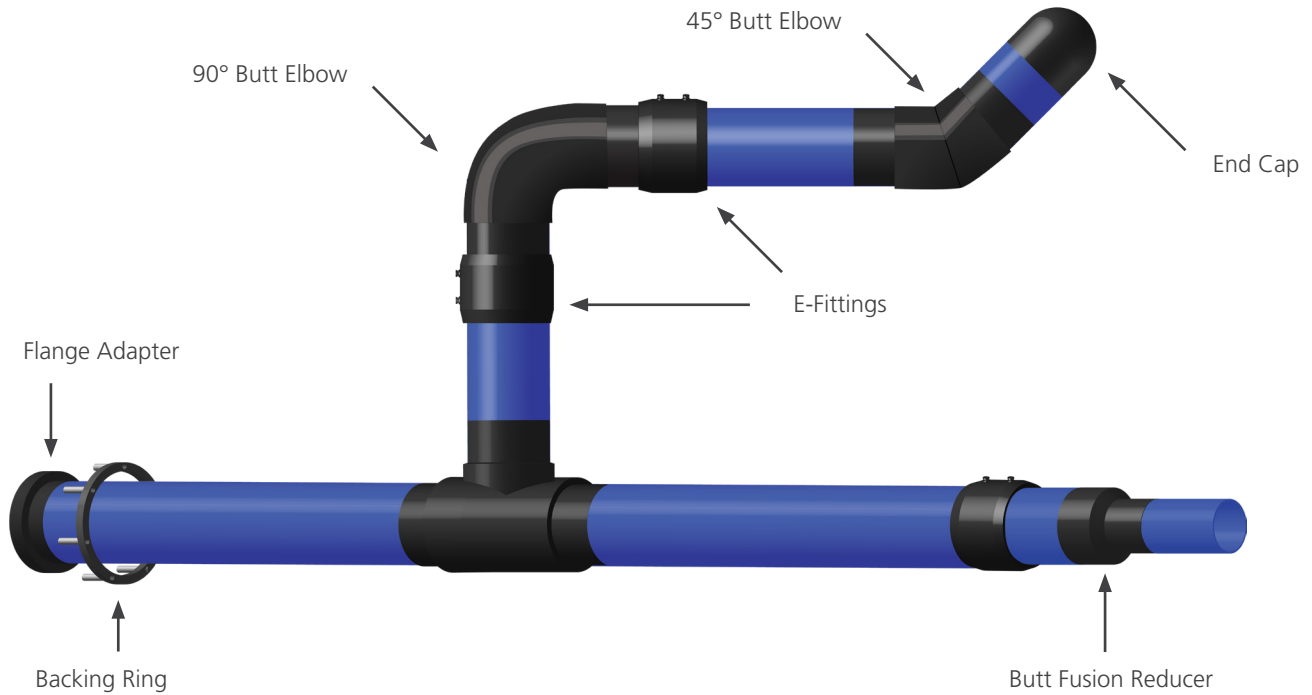

HDPE Pipe Fittings

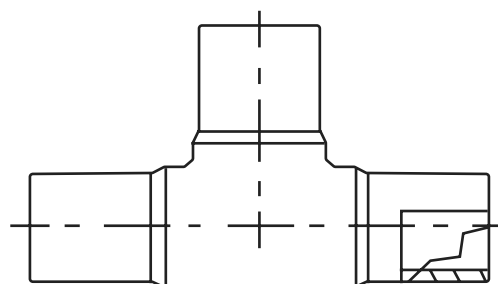

Butt Fusion Tees

- Injection molded from PE 100/PE 4710 material
- Available in both SDR 11 and SDR 17 (soon to be SDR 7 and 9)
- Size range: 3/4" IPS through 12" IPS.

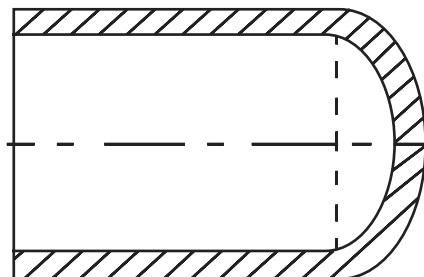

Butt Fusion End Caps

- Injection molded from PE 100/PE 4710 material
- Available in SDR 7, SDR 9, SDR 11, and SDR 17
- Size range: 3/4" IPS through 12" IPS.

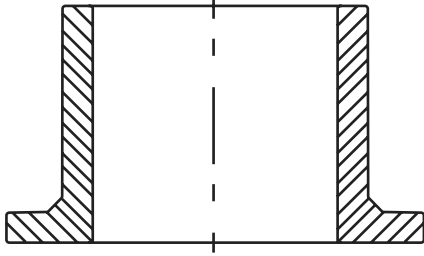

Flange Adapters

- Injection molded from PE 100/PE 4710 material
- Available in both SDR 11 and SDR 17 (soon to be SDR 7 and 9)
- Size range: 3/4" IPS through 18" IPS

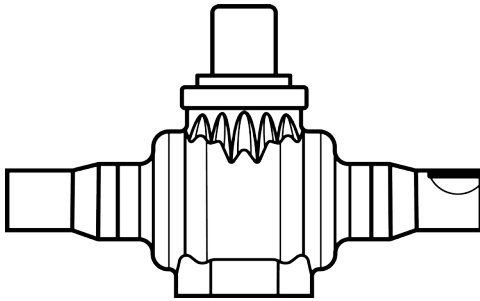

Butt Fusion Ball Valves

- Injection molded from PE 100/PE 4710 in accordance with D2513
- Water version is black and NSF approved
- Gas version is light orange
- Available in 2" to 8" IPS end connections.

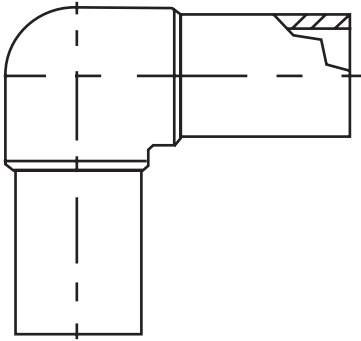

Butt Fusion 45 Degree Elbows and Butt Fusion 90 Degree Elbows

- Injection molded from PE 100/PE 4710 material
- Available in both SDR 11 and SDR 17 (soon to be SDR 7 and 9)
- Size range: 3/4" IPS through 12" IPS.

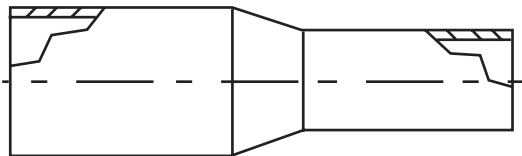

Butt Fusion Reducers

- Injection molded from PE 100/PE 4710 material
- Available in both SDR 11 and SDR 17 (soon to be SDR 7 and 9)
- Call for available sizes

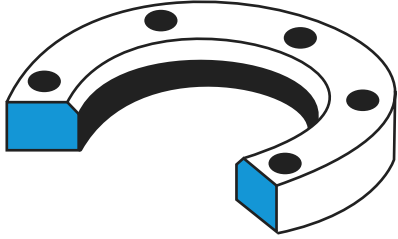

Ductile Iron and PP Backing Rings

- Available in SDR 7 and SDR 11 ratings (limited size ranges)
- Coated with epoxy or red oxide primer
- Different models available from 1/2" to 36" IPS.

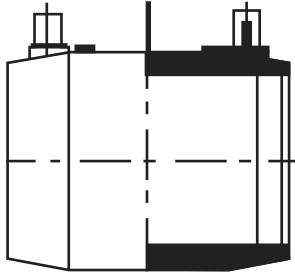

Electrofusion Couplers

- Injection molded from PE 100/PE 4710 material
- Fusion barcode and traceability barcodes on each fitting
- 4.0 mm fusion connectors
- Available in 145 psi and 230 psi versions
- Size range: 1/2" IPS through 48" IPS.

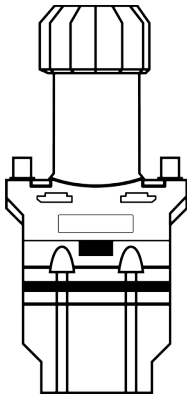

Electrofusion Tapping Saddle

- Injection molded from PE100/PE 4710 material
- Barcoded to facilitate automated fusion and traceability
- Main Sizes: 2" IPS through 6" IPS
- Outlet Sizes: 1/2" CTS through 1" IPS.

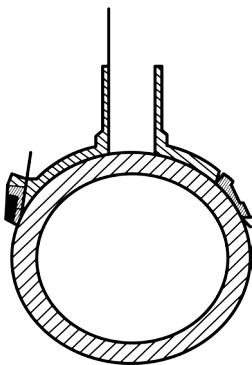

Electrofusion Branch Saddle

- Injection molded from PE100/PE 4710 material
- Barcoded to facilitate automated fusion and traceability
- Main sizes: 3" IPS through 12" IPS
- Outlet sizes: 1" IPS through 4" IPS.

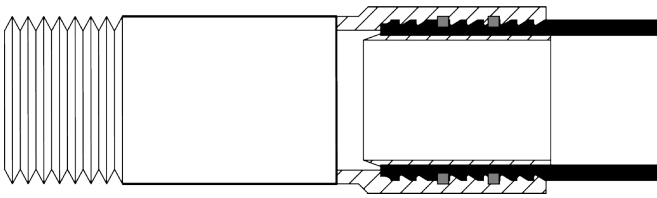

Transition Fittings

- Available in Category 1 (Category 3 models coming soon)
- Meets all requirements for ASTM F1973 and ASTM D2513
- Currently 1 1/4" – 4" IPS sizes
- Thread end and weld end currently available
- Multiple finishes available including carbon steel, epoxy coating, and S/S



Semi-Finished Products

- AGRU now carries HDPE pipe grade sheet stock and welding rods
- HDPE PE100, NSF61 approved sheet stock is available from 1/2" to 2" IPS thickness
- HDPE PE100, PE100RC welding rod is available.



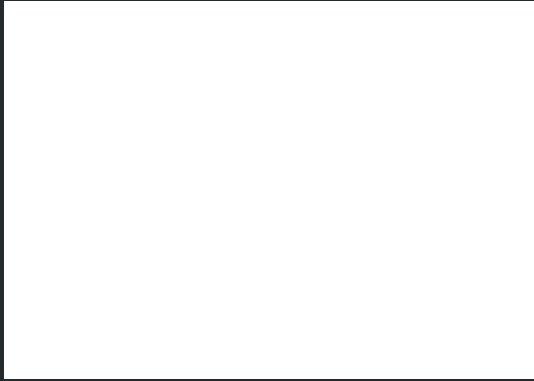
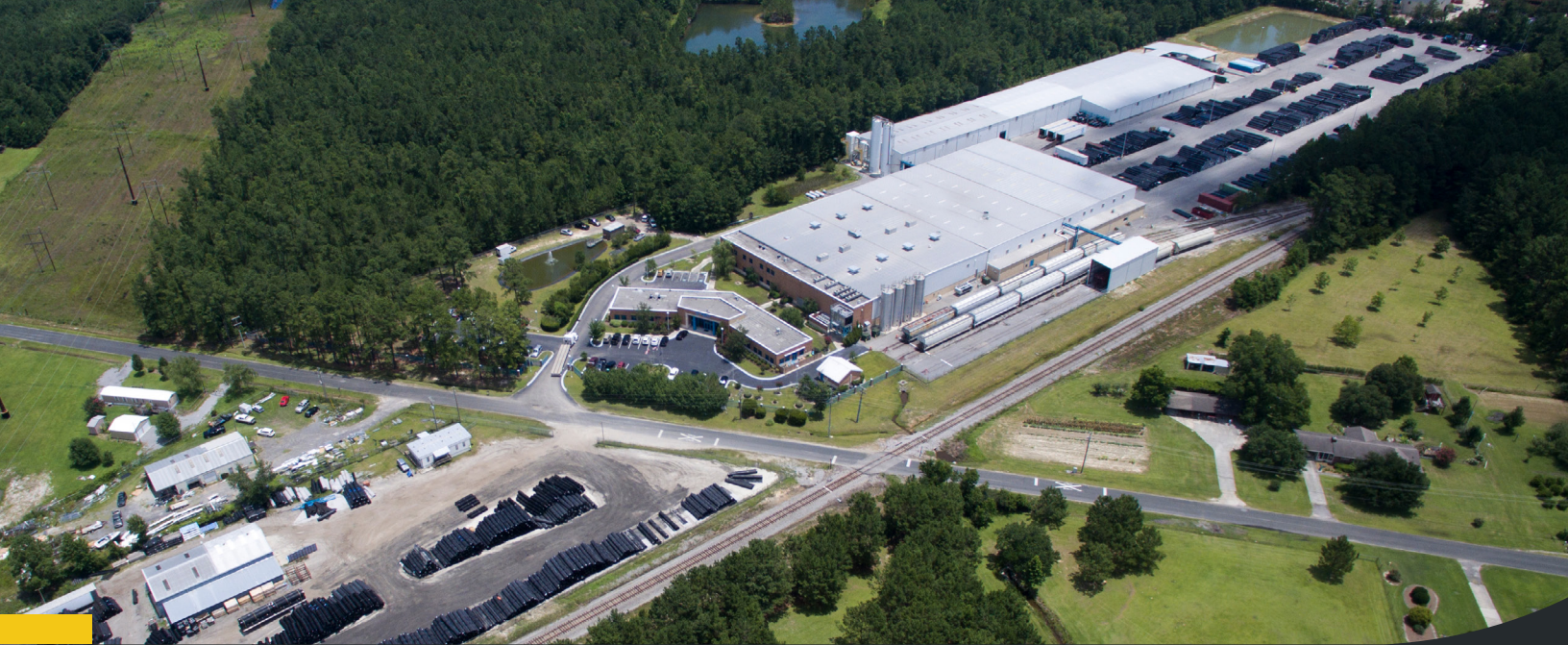

Subject to errors of typesetting, misprints and modifications.
Illustrations are generic and for reference only.

AGRU America
500 Garrison Road
Georgetown, SC 29440
USA

T. +1 800 373 2478
F. +1 843 546 0516
salesmkg@agruamerica.com
Revision Date: November 13, 2017

